



# EXPERIMENTAL ANALYSIS OF THE LINE-SIDE INTERPHASE TRANSFORMER MAGNETIZING CURRENTS IN THREE-PHASE OUTPUT VOLTAGE TYPE RECTIFIERS

Dejana Čučak<sup>1</sup>, Predrag Pejović<sup>1</sup>, Johann W. Kolar<sup>2</sup>

<sup>1</sup>Faculty of Electrical Engineering, University of Belgrade, Belgrade, Serbia

<sup>2</sup>Swiss Federal Institute of Technology, Zürich, Switzerland

**Abstract:** Magnetizing currents of a line-side interphase transformer applied in a three-phase twelve-pulse voltage output type rectifiers are analyzed. Waveforms of the transformer voltages are derived. It is shown that fluxes of the core limbs contain a significant zero-sequence component, resulting in a stray flux and high magnetizing currents. Application of three single-phase cores is proposed. The results are experimentally verified.

**Keywords:** AC-DC power conversion, converters, harmonic distortion, power conversion harmonics, power quality, rectifiers.

## 1. INTRODUCTION

A magnetic device applied in the three-phase twelve-pulse voltage output type rectifier shown in Fig. 1 is analyzed in this paper. The device is designated by a dotted rectangle in Fig. 1, and it is named line-side interphase transformer [1]. Three-phase rectifiers of the output voltage type are analyzed in [1–4]. They are characterized by simple and robust construction, requiring only passive elements. Analysis of a voltage-loaded six-pulse rectifier applying sinusoidal approximation is given in [5]. The analysis applies for the continuous conduction mode. In the case resistive losses can be neglected, an exact solution for the rectifier model is presented in [6]. The analyses of [5, 6] are extended for the twelve-pulse output voltage type rectifiers in [7]. Experimental verification of the sinusoidal approximation approach is given in [8].

The line-side interphase transformer input voltages  $v_{Tk}$ ,  $k \in \{1, 2, 3\}$ , in the continuous conduction mode have twelve-pulse waveforms, obtained as linear combinations of the output voltages  $v_{Ak}$  and  $v_{Bk}$ . To obtain proper twelve-pulse voltage waveforms, the line-side interphase transformer turns ratio should be set to  $p = (\sqrt{3} - 1)/2 \approx 0.366$  [1]. The line-side interphase

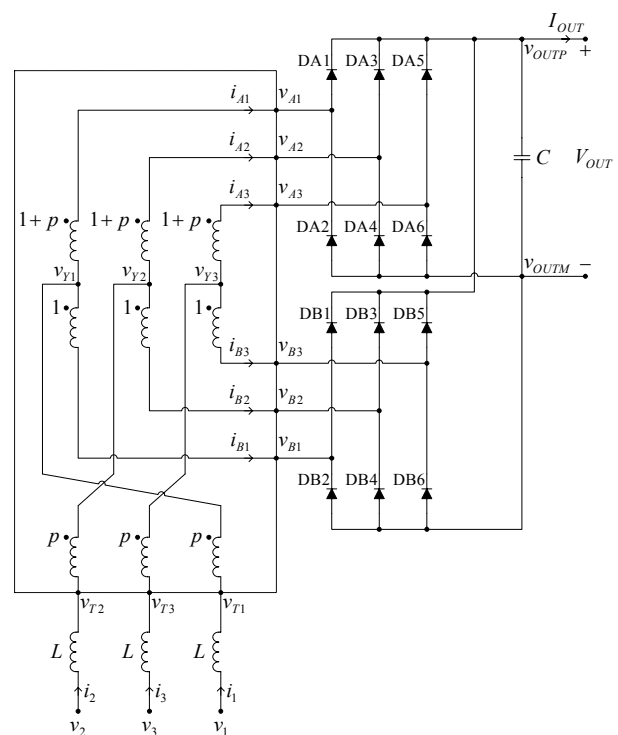

Fig. 1. The rectifier

transformer output currents are  $i_{Ak}$  and  $i_{Bk}$ , while the input currents are  $i_k$ ,  $k \in \{1, 2, 3\}$ .

Goal of this paper is to determine magnetizing currents of the line-side interphase transformer in the continuous conduction mode of the rectifier, and to analyze how does the transformer construction affect the magnetizing currents.

## 2. THE WAVEFORMS

It is assumed that the rectifier is supplied by an undistorted symmetrical three-phase voltage system

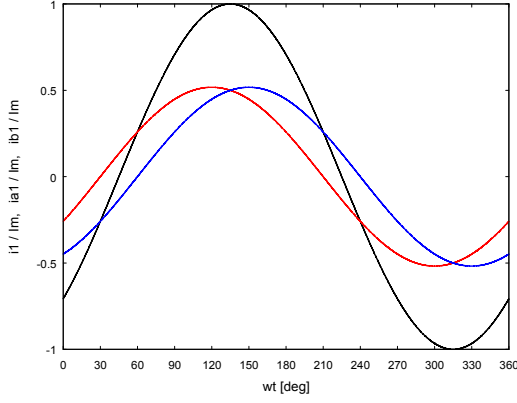

Fig. 2. Waveforms of  $i_1$  (black),  $i_{A1}$  (red), and  $i_{B1}$  (blue)

$$v_k = V_m \sin\left(\omega t - (k-1)\frac{2\pi}{3}\right) \quad (1)$$

for  $k \in \{1, 2, 3\}$ . The voltage system does not contain the zero-sequence component since

$$v_1 + v_2 + v_3 = 0. \quad (2)$$

The rectifier is connected to the mains as a three-wire system, resulting in

$$i_1 + i_2 + i_3 = 0 \quad (3)$$

according to Kirchoff's current law. The line-side interphase transformer input voltages  $v_{Tk}$  are given by

$$v_{Tk} = v_k - L \frac{di_k}{dt}. \quad (4)$$

According to (2) and (3), this provides

$$v_{T1} + v_{T2} + v_{T3} = 0 \quad (5)$$

which is used to determine  $v_{OUTP}$  and  $v_{OUTM}$ .

It is assumed that capacitance of the filtering capacitor is large, resulting in negligible output voltage ripple. In that case, the output voltage

$$V_{OUT} = v_{OUTP} - v_{OUTM} \quad (6)$$

is assumed as constant.

The sinusoidal approximation [7, 8] assumes currents of the inductors as sinusoidal, specified by

$$i_k = I_m \sin\left(\omega t - \phi - (k-1)\frac{2\pi}{3}\right) \quad (7)$$

where  $I_m$  is the input current amplitude, and  $\phi$  is the phase lagging of the input currents with regard to corresponding phase voltages. Values for both of the parameters are determined applying the sinusoidal approximation analysis [7, 8].

According to the equations that characterize the line-side interphase transformer [7, 8], its output currents are given by

$$i_{Ak} = \frac{\sqrt{3}-1}{\sqrt{2}} I_m \sin\left(\omega t - \phi + \frac{\pi}{12} - (k-1)\frac{2\pi}{3}\right) \quad (8)$$

and

$$i_{Bk} = \frac{\sqrt{3}-1}{\sqrt{2}} I_m \sin\left(\omega t - \phi - \frac{\pi}{12} - (k-1)\frac{2\pi}{3}\right). \quad (9)$$

Waveforms of  $i_1$ ,  $i_{A1}$ , and  $i_{B1}$  for  $\phi = 45^\circ$  are given in Fig. 2.

Polarity of the line-side interphase transformer output currents  $i_{Ak}$  and  $i_{Bk}$  determine states of the diodes in the diode bridges as

$$DA_{2k-1} = \begin{cases} 1, & \text{if } i_{Ak} > 0 \\ 0, & \text{if } i_{Ak} < 0 \end{cases} \quad (10)$$

$$DA_{2k} = \begin{cases} 1, & \text{if } i_{Ak} < 0 \\ 0, & \text{if } i_{Ak} > 0 \end{cases} = 1 - DA_{2k-1} \quad (11)$$

$$DB_{2k-1} = \begin{cases} 1, & \text{if } i_{Bk} > 0 \\ 0, & \text{if } i_{Bk} < 0 \end{cases} \quad (12)$$

and

$$DB_{2k} = \begin{cases} 1, & \text{if } i_{Bk} < 0 \\ 0, & \text{if } i_{Bk} > 0 \end{cases} = 1 - DB_{2k-1} \quad (13)$$

for  $k \in \{1, 2, 3\}$ . At this point, it is convenient to define auxiliary variables that contain numbers of conducting diodes in a certain diode group as

$$DA_{UP} = DA_1 + DA_3 + DA_5 \quad (14)$$

$$DA_{DN} = DA_2 + DA_4 + DA_6 \quad (15)$$

$$DB_{UP} = DB_1 + DB_3 + DB_5 \quad (16)$$

and

$$DB_{DN} = DB_2 + DB_4 + DB_6. \quad (17)$$

In the continuous conduction mode, in each diode bridge and in each time point three diodes are conducting, thus

$$DA_{UP} + DA_{DN} = 3 \quad (18)$$

and

$$DB_{UP} + DB_{DN} = 3. \quad (19)$$

Voltages of the line-side interphase transformer output terminals can take only two values,  $v_{OUTP}$  and  $v_{OUTM}$ , depending on the corresponding output current polarity. In terms of the diode state functions, this is expressed as

$$v_{Ak} = DA_{2k-1}v_{OUTP} + DA_{2k}v_{OUTM} \quad (20)$$

and

$$v_{Bk} = DB_{2k-1}v_{OUTP} + DB_{2k}v_{OUTM}. \quad (21)$$

The line-side interphase transformer input voltages are determined by (4) of [8]. Summing up the input terminal voltages and applying (5), the first equation over  $v_{OUTP}$  and  $v_{OUTM}$  is obtained as

$$\left( (2 - \sqrt{3})DA_{UP} + (\sqrt{3} - 1)DB_{UP} \right) v_{OUTP} + \left( (2 - \sqrt{3})DA_{DN} + (\sqrt{3} - 1)DB_{DN} \right) v_{OUTM} = 0 \quad (22)$$

while the second one is

$$V_{OUT} = v_{OUTP} - v_{OUTM}. \quad (23)$$

As already stated, in the continuous conduction mode, in each diode bridge, in each time point, three diodes are conducting. As a consequence of Kirchoff's current law, all three of the conducting diodes cannot be from the upper diode group (odd indexed), neither from the lower diode group (even indexed), meaning that at least one diode in each group must be conducting. Thus, for the two diode bridges there is a total of four possible combinations for the numbers of conducting diodes, as summarized in Table 1. For each of the combinations there is a solution for the rectifier output terminal voltages, as given in Table 1. For the input currents

Table 1. Values of the rectifier output terminal voltages

$DA_{UP}$	$DB_{UP}$	$v_{OUTP}$	$v_{OUTM}$
1	1	$\frac{2}{3}V_{OUT}$	$-\frac{1}{3}V_{OUT}$
1	2	$\frac{3-\sqrt{3}}{3}V_{OUT}$	$-\frac{\sqrt{3}}{3}V_{OUT}$
2	1	$\frac{\sqrt{3}}{3}V_{OUT}$	$-\frac{3-\sqrt{3}}{3}V_{OUT}$
2	2	$\frac{1}{3}V_{OUT}$	$-\frac{2}{3}V_{OUT}$

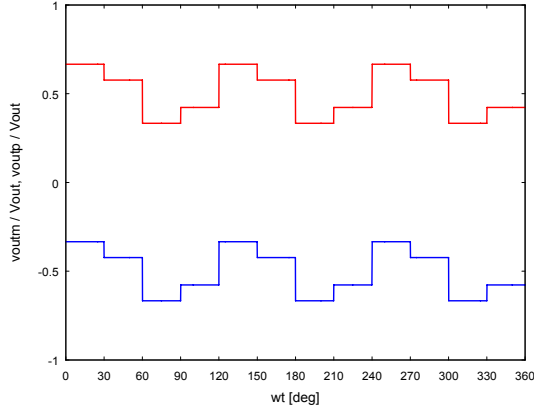

Fig. 3. Waveforms of  $v_{OUTP}$  (red) and  $v_{OUTM}$  (blue)

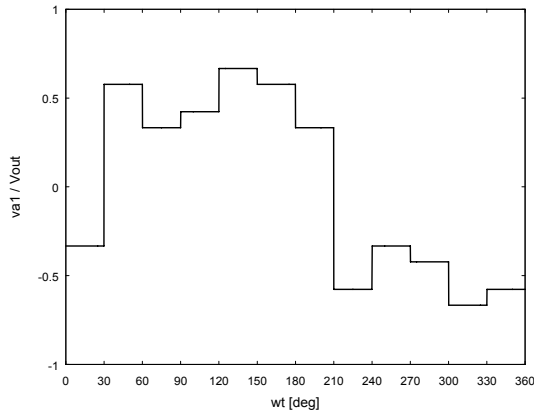

Fig. 4. Waveform of  $v_{A1}$

assumed by (7), resulting waveforms of the output terminal voltages are given in Fig. 3.

After the rectifier output terminal voltages are known, the line-side interphase transformer output terminal voltages are determined according to (20) and (21), and the resulting waveforms for  $v_{A1}$  and  $v_{B1}$  are shown in Figs. 4 and 5. The line-side interphase transformer output terminal voltages determine the input terminal voltages according to (4) of [8], and the resulting waveform of  $v_{T1}$  is shown in Fig. 6, which is used in [7, 8] to complete the sinusoidal approximation based analysis, taking only fundamental harmonics of  $v_{T_k}$  into account.

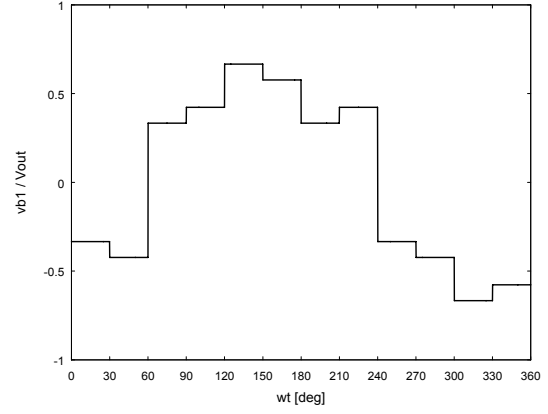

Fig. 5. Waveform of  $v_{B1}$

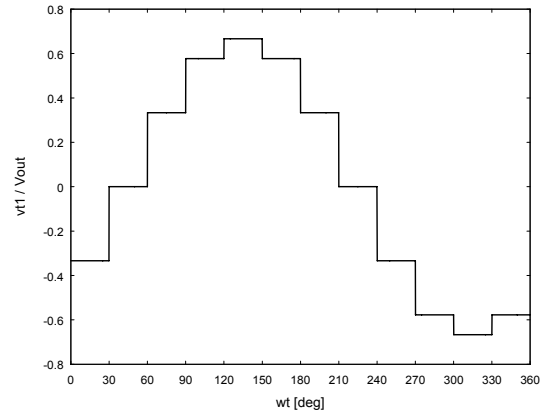

Fig. 6. Waveform of  $v_{T1}$

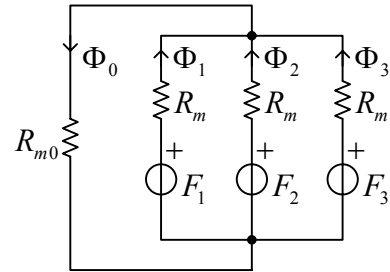

Fig. 7. Equivalent magnetic circuit for the line-side interphase transformer core

### 3. MAGNETIZING CURRENTS

Let us assume that the line-side interphase transformer is wound around a three-phase three-limb core that can be modeled by an equivalent magnetic circuit shown in Fig. 7. Limb reluctance is represented by  $R_m$ , while the leakage air reluctance is represented by  $R_{m0}$ . In practice,  $R_{m0} \gg R_m$ . Perfect coupling is assumed. The limb fluxes  $\Phi_k$  are generated by magnetomotive forces  $F_k$ ,  $k \in \{1, 2, 3\}$ . It is assumed that the magnetizing current is associated to the windings with the normalized number of turns equal to 1, actual number of turns being  $n$ . Thus, the voltages across the magnetizing windings are

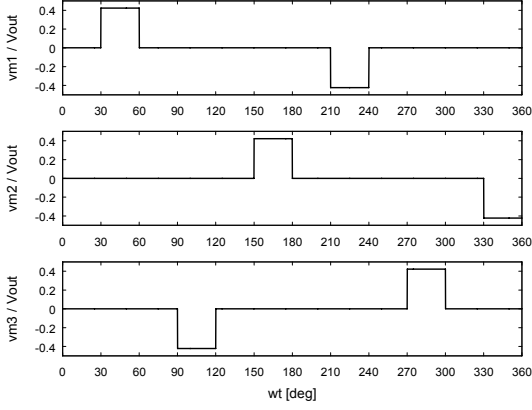

Fig. 8. Voltages across the magnetizing windings

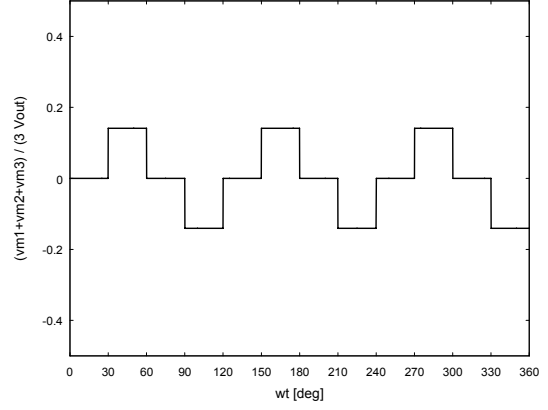

Fig. 10. Zero sequence of the voltages across the magnetizing windings

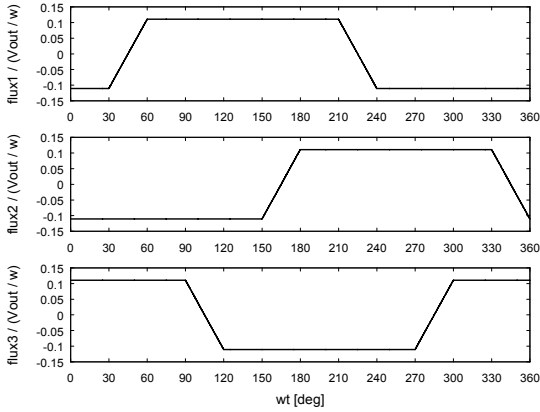

Fig. 9. Waveforms of the limb fluxes

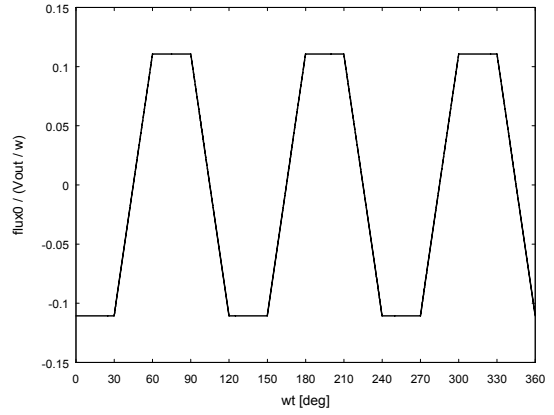

Fig. 11. Waveform of the stray flux

$$v_{Mk} = v_{Yk} - v_{Bk} \quad (24)$$

for  $k \in \{1, 2, 3\}$ . It is convenient to express the magnetizing voltages in terms of  $v_{Ak}$  and  $v_{Bk}$  determined by (20) and (21) as

$$v_{Mk} = \frac{v_{Ak} - v_{Bk}}{2 + p}. \quad (25)$$

Voltages across the transformer windings are obtained as time derivatives of the corresponding limb fluxes  $\Phi_k$  multiplied by the corresponding number of turns of the winding, according to Faraday's law. For the magnetizing windings, this results in

$$v_{Mk} = n \frac{d\Phi_k}{dt}. \quad (26)$$

Waveforms of all three of the magnetizing voltages are depicted in Fig. 8. These waveforms result in the limb fluxes shown in Fig. 9, being determined applying (26). The system of magnetizing voltages contains significant zero-sequence component, shown in Fig. 10.

Conservation of flux yields

$$\Phi_0 = \Phi_1 + \Phi_2 + \Phi_3 \quad (27)$$

resulting in a significant stray flux with the waveform shown in Fig. 11. Since  $R_m \ll R_{m0}$ , magnetomotive force drop across  $R_m$  reluctances is negligible in comparison to the magnetomotive force drop across  $R_{m0}$ . In this manner, the magnetomotive forces required to magnetize the core are obtained as

$$F_1 = F_2 = F_3 = R_{m0} \Phi_0. \quad (28)$$

The magnetomotive forces are obtained as a product of the magnetizing current and the number of turns of the magnetizing winding,

$$F_k = n i_{Mk}. \quad (29)$$

Taking the time derivative of (28) yields

$$\frac{dF_k}{dt} = R_{m0} \frac{d\Phi_0}{dt}. \quad (30)$$

Substituting (26), (27) and (29) into (30) provides

$$\frac{di_{Mk}}{dt} = L_{mzs} \frac{v_{M1} + v_{M2} + v_{M3}}{3} \quad (31)$$

where

$$L_{mzs} = 3 \frac{R_{m0}}{n^2} \quad (32)$$

is the zero sequence magnetizing inductance.

According to (31), all three of the magnetizing currents have the same waveform, proportional to the waveform of  $\Phi_0$  given in Fig. 11, but with the amplitude equal to

$$I_{m \max} = \frac{\pi}{6(3 + \sqrt{3})} \frac{R_{m0}}{n} \frac{V_{OUT}}{\omega}. \quad (33)$$

To reduce the magnetizing currents,  $R_{m0}$  should be reduced as much as possible. This may be achieved applying five-limb core, core of the shell type, or applying three single-phase cores.

#### 4. VA RATING OF THE LINE-SIDE INTERPHASE TRANSFORMER

After the voltages and currents of the line-side interphase transformer are known, its VA rating can be determined. According to [9], in the case three single-phase cores are applied the VA rating of each core is

$$S_{T1} = \frac{6 + 3\sqrt{2} - \sqrt{6}}{1728} \pi^2 P_{OUT} \approx 4.45\% P_{OUT}. \quad (34)$$

It should be underlined here that the result of (34) is applicable only if the rectifier is designed to operate at a fixed operating point, i.e. fixed output power. If the operating point varies, the VA rating is higher, since at low output currents the output voltage is high, resulting in increased flux stress on the core, while at high output currents the flux in the core is reduced, but the RMS values of the currents in the line-side interphase transformer windings are increased. Thus, the core should be dimensioned not to saturate at low output currents, while the windings should be dimensioned not to overheat at high output currents. These requirements cause the VA rating to be higher than specified by (34), the increase being dependent on the operating point variation.

Normalized rated power of the inductors is computed according to [9] as

$$S_L = \frac{1}{4} J_m^2 = \frac{\pi^2}{288(2 - \sqrt{3})} J_{OUT}^2 \quad (35)$$

and it cannot be expressed as a single-variable function of the output power.

#### 5. EXPERIMENTAL RESULTS

To verify the results, two rectifier models were made, one using the line-side interphase transformer with a three-phase core, and the other one with three single-phase cores. The rectifiers were operated with  $V_m = 32$  V, and the diagrams were recorded at  $I_{OUT} = 5$  A, where the three-phase core provided  $V_{OUT} = 20$  V, while the version with single-phase cores provided  $V_{OUT} = 27$  V, indicating significantly increased efficiency.

Waveforms of  $i_{A1}$ ,  $v_{A1}$ ,  $i_{A2}$ , and  $v_{A2}$  are shown in Fig. 12 for the three-phase core version, while for the single-phase version the same waveforms are given in Fig. 13. The waveforms of  $v_{A1}$  and  $v_{A2}$  are in agreement with the predictions of Fig. 4, except for the slight curving caused by the resistive voltage drop on the windings, pronounced in the three-phase core version. Currents  $i_{A1}$  and  $i_{A2}$  are significantly more distorted in the three-phase case in comparison to the single-phase case. Waveforms of  $i_{A1} + i_{A2} + i_{A3}$  and  $i_{B1} + i_{B2} + i_{B3}$  that contain the waveform of the magnetizing currents, accompanied by the waveforms of  $v_{M1}$  and  $v_{M2}$  are shown in Figs. 14 (three-phase core version) and 15 (three single-phase cores version). Comparing the waveforms, it is concluded that in the three-phase version the magnetizing currents are reduced for about 27 times, resulting in reduced ringing currents and

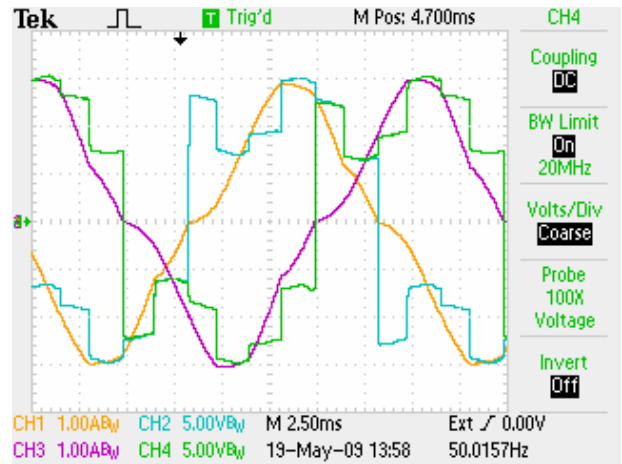

Fig. 12. Waveforms of  $i_{A1}$ ,  $v_{A1}$ ,  $i_{A2}$ , and  $v_{A2}$ , three-phase core

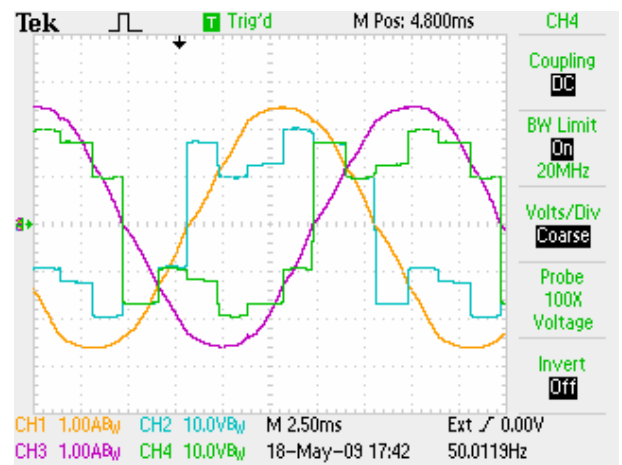

Fig. 13. Waveforms of  $i_{A1}$ ,  $v_{A1}$ ,  $i_{A2}$ , and  $v_{A2}$ , three single-phase cores

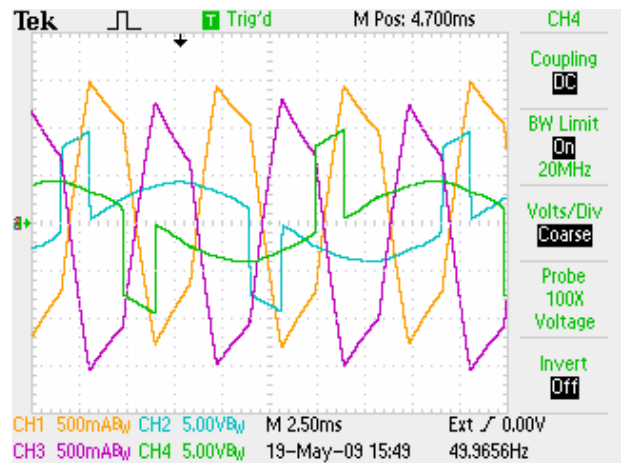

Fig. 14. Waveforms of  $\sum i_A$ ,  $\sum i_B$ ,  $v_{M1}$ ,  $v_{M2}$ , three-phase core

losses. The waveforms of  $v_{M1}$  and  $v_{M2}$  are distorted in comparison to the prediction of Fig. 8 for the resistive voltage drop across the windings, not included in the analysis. The distortion is higher in the three-phase case.

Regardless the fact that losses in the transformer windings were not taken into account in the analysis, the idealized analytical approach successfully predicted relevant behavior of the converter, including the magnetizing currents.

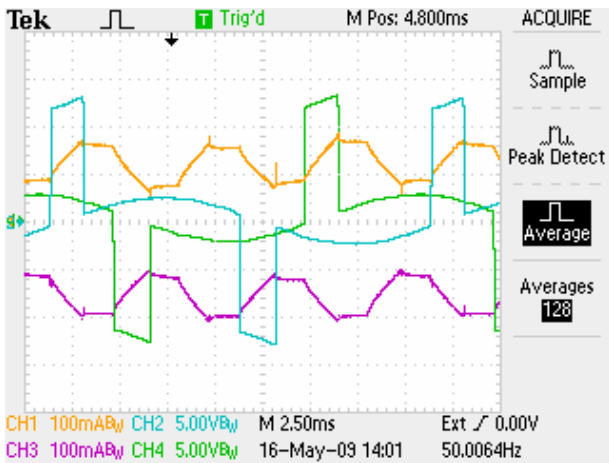

Fig. 15. Waveforms of  $\sum i_A$ ,  $\sum i_B$ ,  $v_{M1}$ ,  $v_{M2}$ , three single-phase cores

## 6. CONCLUSIONS

Magnetizing currents of the line-side interphase transformer in a twelve-pulse three-phase voltage output type rectifier are analyzed in the paper. Waveforms of the transformer voltages are derived assuming sinusoidal input currents and neglecting losses in the rectifier components. Integrating the transformer voltage waveforms, fluxes in the core limbs are determined. It is shown that the fluxes contain a significant zero-sequence component, resulting in a stray flux and high magnetizing currents. In the experiment, the magnetizing currents caused ringing zero sequence currents that degraded the rectifier efficiency. To control the stray flux and to reduce the magnetizing currents, either five-limb core, shell-type core, or three single-phase cores should be applied. Application of three single-phase cores is experimentally verified as an appropriate solution.

## 7. REFERENCES

- [1] M. Depenbrock, C. Niermann, "A new 12-pulse rectifier with line-side interphase transformer and nearly sinusoidal line currents," *Proceedings of the Power Electronics and Motion Control Conference*, Budapest, 1990, pp. 374-378.
- [2] C. Niermann, "New rectifier circuits with low mains pollution and additional low cost inverter for energy recovery," *Proceedings of the European Power Electronics Conference*, Aachen, 1989, pp. 1131-1136.
- [3] M. Depenbrock, C. Niermann, "A new 18-pulse rectifier circuit with line-side interphase transformer and nearly sinusoidal line currents," *Proceedings of the 2nd International Power Electronics Conference (IPEC)*, Tokyo, 1990, pp. 539-546.
- [4] P. Mysiak, "A 24-pulse diode rectifier with coupled three-phase reactor," *Journal of the Chinese Institute of Engineers*, Vol. 30, No. 7, pp. 1197-1212, 2007.
- [5] V. Caliskan, D. J. Perreault, T. M. Jahns, and J. G. Kassakian, "Analysis of three-phase rectifiers with constant-voltage loads," *IEEE Trans. Circuits Syst. I, Fundam. Theory Appl.*, vol. 50, no. 9, pp. 1220-1226, Sep. 2003.
- [6] P. Pejović, J. W. Kolar, "Exact analysis of three-phase rectifiers with constant voltage loads," *IEEE Transactions on Circuits and Systems-II: Express Briefs*, vol. 55, no. 8, pp. 743-747, Aug. 2008.
- [7] P. Pejović, J. W. Kolar, "Analysis of a three-phase twelve-pulse voltage output type rectifier," submitted for review.
- [8] P. Pejović, J. W. Kolar, V. Šviković, "Sinusoidal Approximation in the Analysis of Twelve-Pulse Output Voltage Type Rectifiers," *15<sup>th</sup> International Symposium of Power Electronics*, Novi Sad, 2009.
- [9] P. Pejović, *Three-Phase Diode Rectifiers with Low Harmonics*, Springer, 2007.